

Removing and Replacing Parts: Dell™ Inspiron™ 5000 Series

NOTICE: Only a certified service technician should perform repairs on your computer. Damage or inoperability due to servicing not authorized by Dell is not covered by your warranty.

- [Overview](#)
- [Precautionary Measures](#)
- [Recommended Tools](#)
- [Customer-Accessible Components](#)
- [Screw Counts and Locations](#)
- [ZIF Connectors](#)
- [Modem Removal](#)
- [Hinge Cover Removal](#)
- [Keyboard Removal](#)
- [Thermal Shield Removal](#)
- [Processor Module Removal](#)
- [LCD Removal](#)
- [Video Board Removal](#)
- [Diskette Drive Removal](#)
- [Palmrest Removal](#)
- [Speaker and Volume Board Removal](#)
- [Support Rail Removal](#)
- [Infrared Board Removal](#)
- [System Board Removal](#)
- [14.1-Inch XGA Display Disassembly](#)
- [15-Inch UXGA, XGA, and SXGA+ Display Disassembly](#)

Overview

Unless otherwise noted, each procedure assumes the following:

- You have the recommended tools.
 - You have performed the steps in [Precautionary Measures](#).
 - The computer and any attached peripherals are turned off and the peripherals are disconnected from the input/output (I/O) panel.
 - You can replace or reinstall a part by performing the removal procedure in reverse order unless additional information is provided.
-

Precautionary Measures

NOTICE: Only a certified service technician should perform repairs on your computer. Damage or inoperability due to servicing not authorized by Dell is not covered by your warranty.

WARNING: FOR YOUR PERSONAL SAFETY AND PROTECTION OF THE EQUIPMENT:

Before you start to work on the computer, perform the following steps in the sequence indicated:

1. Ground yourself by attaching an antistatic grounding strap to your wrist and to an unpainted metal surface on the computer I/O panel. If an antistatic grounding strap is not available, periodically discharge static electricity from your body by touching one of the connectors on the I/O panel.
 2. Turn off the computer and any attached peripherals.
 3. Disconnect the computer and any attached peripherals from electrical outlets to reduce the potential for personal injury or shock.
-

Recommended Tools

NOTICE: Only a certified service technician should perform repairs on your computer. Damage or inoperability due to servicing not authorized by Dell is not covered by your warranty.

Most of the procedures require the use of one or more of the following tools:

- Small flat-blade screwdriver
- Number 1 Phillips-head screwdriver
- Antistatic grounding strap
- Dental pick
- Small scribe or nylon flat blade
- Nut drivers (5 mm and 5.5 mm)

Be careful not to scratch the computer plastic case by allowing screws to get between the work surface and the plastic case. Dell suggests a soft padded work surface.

NOTICE: The correct-length screw must be used when reinstalling a screw. Otherwise, hardware damage could result. Make sure that the screw is properly aligned with its corresponding hole, and avoid excessive tightening.

NOTICE: During the removal and replacement procedures, you will see Kapton tape (grounding tape) in many places on the computer. When reinstalling or replacing parts, be sure to replace the Kapton tape correctly to retain the electrical protection and noise reduction the tape provides.

Customer-Accessible Components

NOTICE: The steps in this section may be performed by customers.

1. Disconnect the AC adapter cable from the computer.



2. If the computer is connected to a port replicator, pull both release handles on the sides of the replicator to undock the computer.



3. Remove the battery from the battery bay:
 - a. Close the display and turn the computer upside-down.
 - b. Slide and hold the battery bay latch away from the battery.

The battery bay latch is located between the battery bay and the media bay.
 - c. Pull the battery out of the bay.

NOTICE: Use the PC Card configuration utility on the taskbar to select and stop a card before removing it from the computer. If you do not remove the card in the configuration utility, you could lose data from open application programs.

4. Remove any PC Cards:

- a. Press the eject button.
- b. When the button slides out, press it again to release the card.
- c. Gently remove the card.
- d. Press the eject button once more until it is flush with the computer casing.

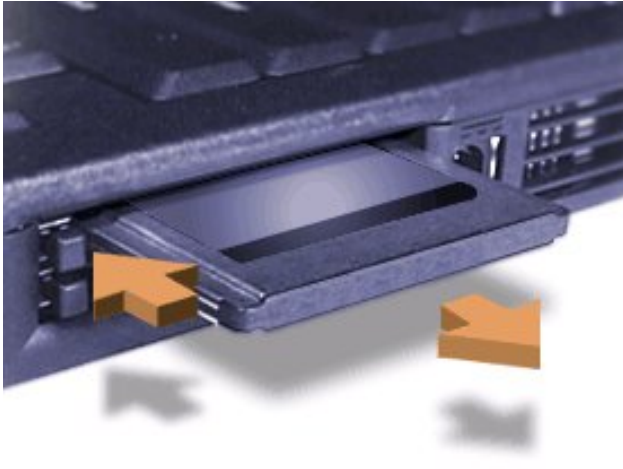

5.

Remove the hard-disk drive assembly:

- a. Turn the computer upside-down.
- b. Remove the screw securing the hard-disk drive cover.
- c. Pull the hard-disk drive carrier out of the computer.

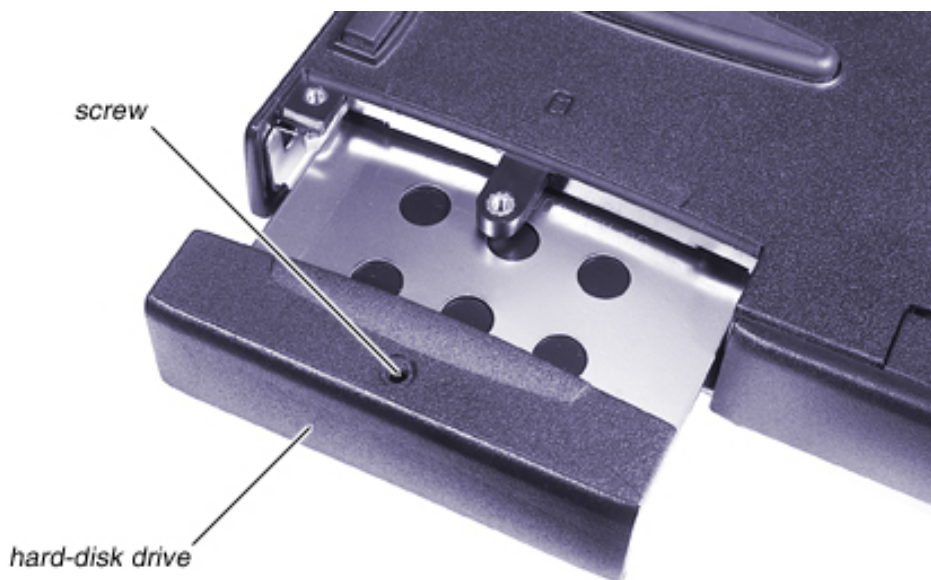

NOTICE: When the hard-disk drive is not in the computer, store it in a hard-disk drive case or protective wrapping to protect it from exposure to static electricity.

NOTICE: Handle the hard-disk drive gently; do not bump or drop the drive. Rough handling of the drive could induce failure or loss of data.

6. Remove the memory module cover:

- a. Turn the computer upside-down.
- b. Remove the two screws from the memory module cover (the larger cover).
- c. Slide the memory module cover as far as it will go towards the middle of the computer, and then remove the cover.

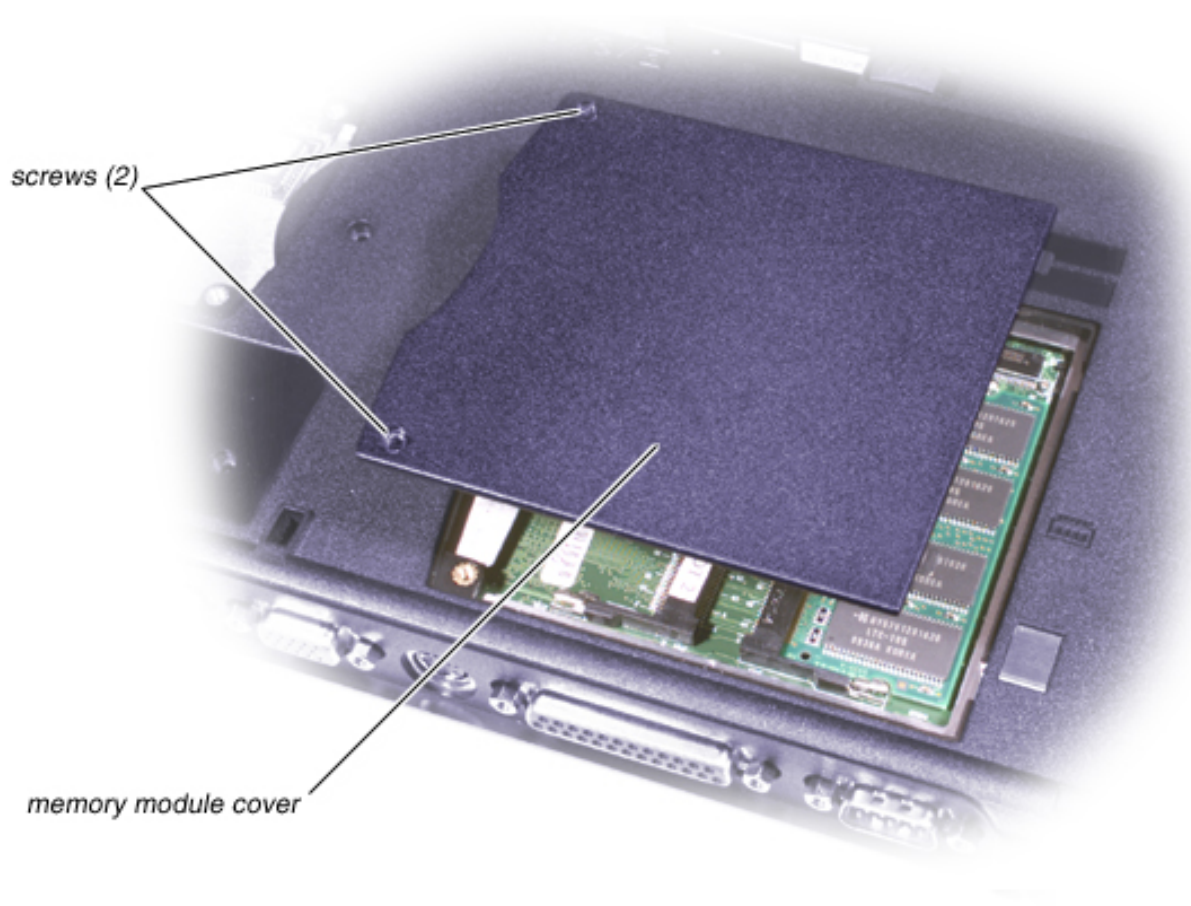

7. Remove the memory modules:

- a. Push the release tabs on either side of the memory module away from the module.
- b. The module will pop up at an angle.
- c. Pull the module from its socket.

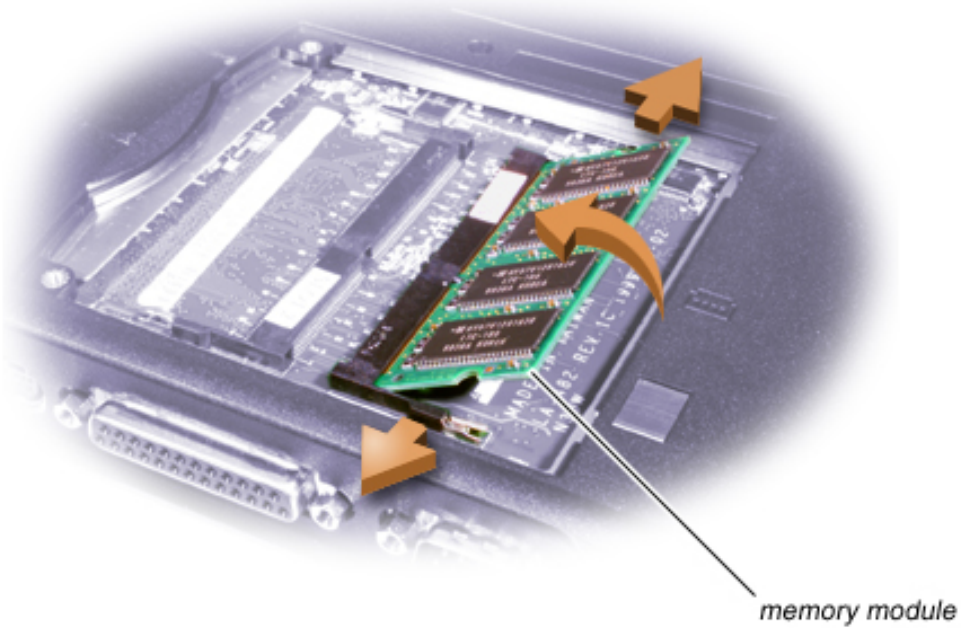

8. Remove the device from the media bay:

- a. Close the display and turn the computer upside-down.
- b. Slide and hold the latch release away from the media bay device.
- c. Pull the device out of the media bay.

latch release

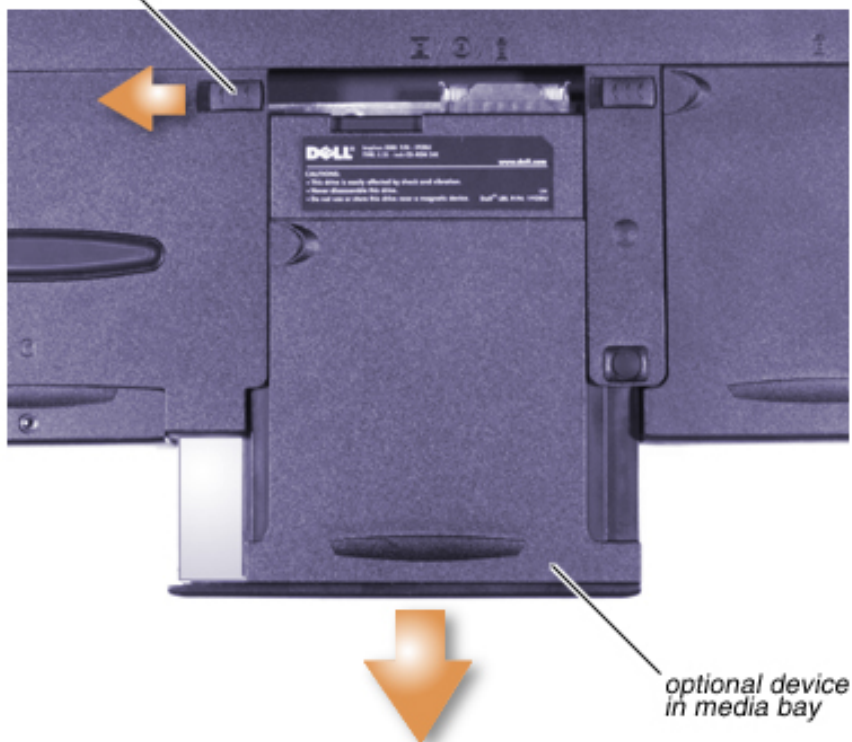

Screw Counts and Locations

NOTICE: Only a certified service technician should perform repairs on your computer. Damage or inoperability due to servicing not authorized by Dell is not covered by your warranty.

You may find it helpful to print the following table to use for keeping the screws organized as you disassemble the computer. The table lists the components from right to left in the order that they are to be removed from the computer.

Hard-Disk Drive 1	Memory 2	Modem 2
Hinge Covers 2 <i>(piece across top of keyboard)</i>	Keyboard 2 (from top)	Thermal Shield 4 (silver) for Inspiron 5000 5 (silver) for Inspiron 5000e <i>(Remove the diskette-drive-cable retaining bracket before removing the thermal shield.)</i>
Processor Module 3 for Inspiron 5000 2 for Inspiron 5000e	LCD Hinges 4 (2 per hinge)	Video Board 1 (silver)
Diskette Drive 2 (bottom of system)	Palmrest 3 (from the top) 4 (bottom of media bay) 5 (bottom of battery bay) 3 (bottom of hard-disk drive bay) 5 (deep wells in base)	Speakers and Volume Board 9 (do not unscrew the speakers) <i>(including both speakers and the volume board)</i>
Support Rail 7 (back of computer) 4 (through top of support rail) <i>(including the fan and the plastic strip)</i>	Infrared Board No screws	System Board 2 (serial port nuts) 2 (parallel port nuts) 2 (VGA port nuts) 2 (APR/PPR port nuts) 2 (screws into base)
15-Inch Display LCD Bezel 2	15-Inch Display LCD Panel 8 (4 per side)	15-Inch Display LCD Locking Tabs 4 (2 each)
14.1-Inch Display LCD Bezel 4	14.1-Inch Display LCD Panel 6 (3 per side)	14.1-Inch Display LCD Locking Tabs 4 (2 each)

LED/Inverter Board

2

ZIF Connectors

NOTICE: ZIF connectors are fragile. To avoid breaking the connectors, touch them carefully. Do not apply too much pressure to the movable part of the connector when opening or closing it.

Some of the interface connectors are zero insertion force (ZIF) connectors. These connectors are not removable; they must be released to disconnect a cable from them.

To disconnect a cable from a ZIF connector, perform the following steps:

1. Insert a small flat-blade screwdriver, dental pick, or fingernail under the movable part of the connector.
2. Pull up gently on the movable part of the connector until the cable is released.

Some ZIF connectors may need to be lifted in the center.

3. Grasp the cable and pull it out of the connector.

To reconnect an interface cable to a ZIF connector, perform the following steps:

1. Open the ZIF connector.
2. Insert the end of the cable into the connector.
3. While holding the cable in place, close the ZIF connector.

To ensure a firm connection, make sure the ZIF connector is completely closed.

Modem Removal

NOTICE: Only a certified service technician should perform repairs on your computer. Damage or inoperability due to servicing not authorized by Dell is not covered by your warranty.

Ensure that all [precautionary measures](#) have been followed and that all [customer-accessible](#) parts are removed.

1. Remove the modem cover.
2. Spread the release tabs on either side of the modem away from the modem.
3. Remove the modem.
4. Remove the modem cable.

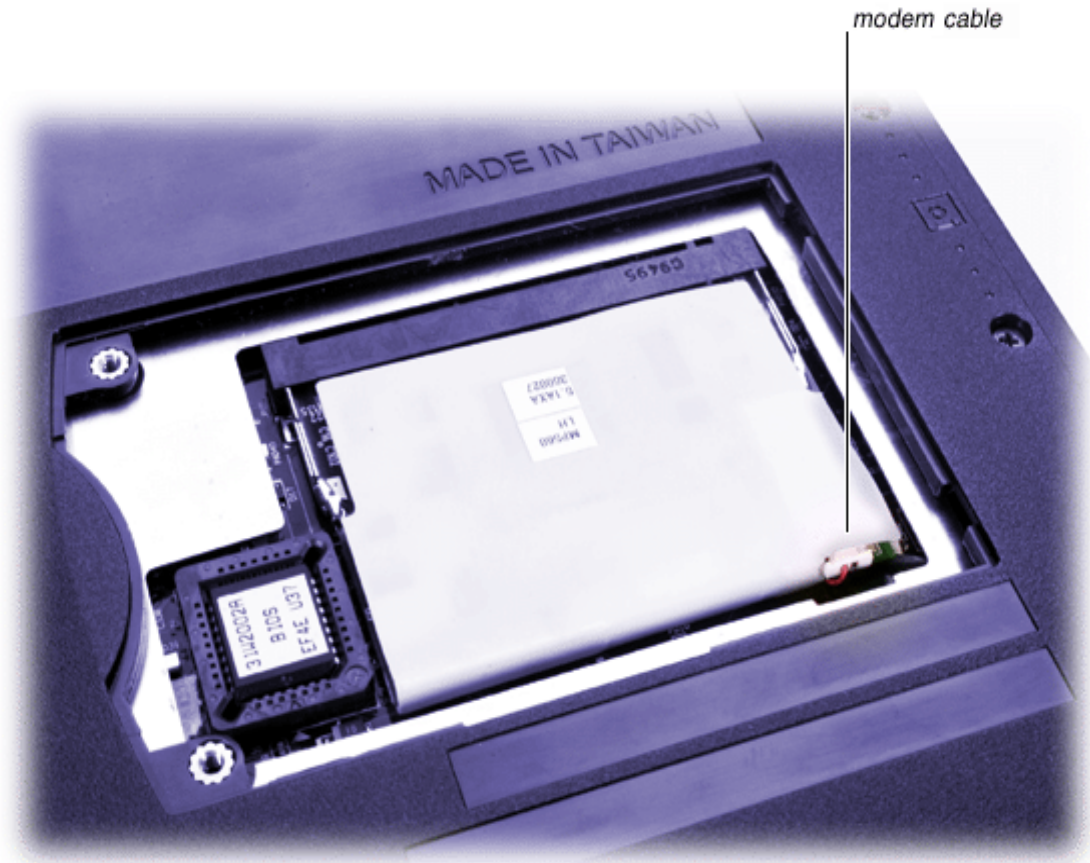

To reinsert the modem when you reassemble the computer, perform the following steps:

1. Attach the modem cable.
2. Insert the modem into the socket, and rock it up and down until it is completely in place.

NOTICE: Fold the modem cable out of the way of the modem door to make sure you do not cut it when you close the modem door.

Hinge Cover Removal

NOTICE: Only a certified service technician should perform repairs on your computer. Damage or inoperability due to servicing not authorized by Dell is not covered by your warranty.

1. Remove the hinge cover screws.

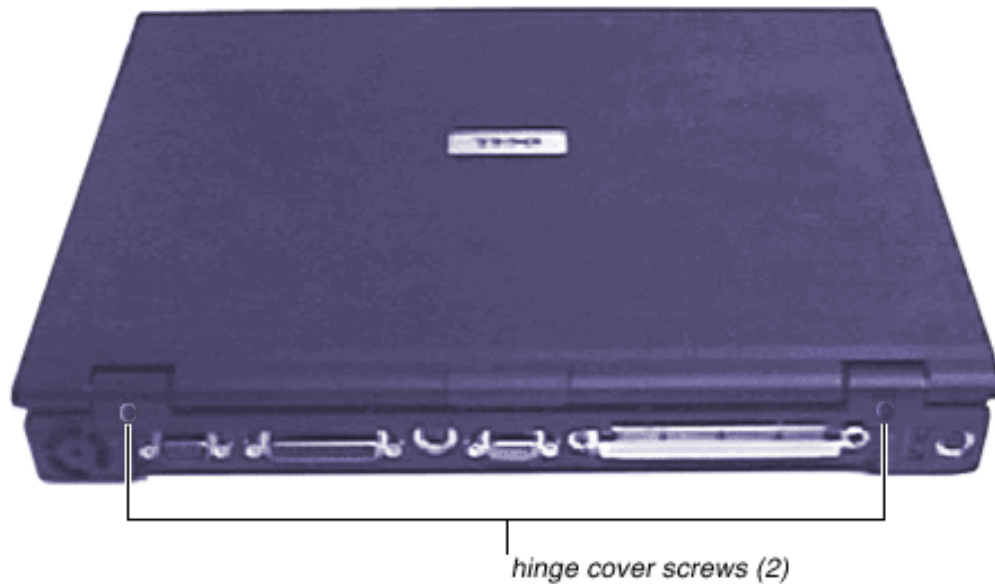

2. Open the display, and lift off the hinge cover by rotating it toward you.

To replace the hinge cover, perform the following steps:

1. Insert the hinge cover at a 45° angle.
2. Press the hinge cover down above the <F4>, <F5>, and <Print Screen> keys.
3. Press down along the entire length of the hinge cover until it fits securely in place.
4. Replace the screws.



Keyboard Removal

NOTICE: Only a certified service technician should perform repairs on your computer. Damage or inoperability due to servicing not authorized by Dell is not covered by your warranty.

1. Remove the screws.

2. Slide the keyboard out from under the palmrest.

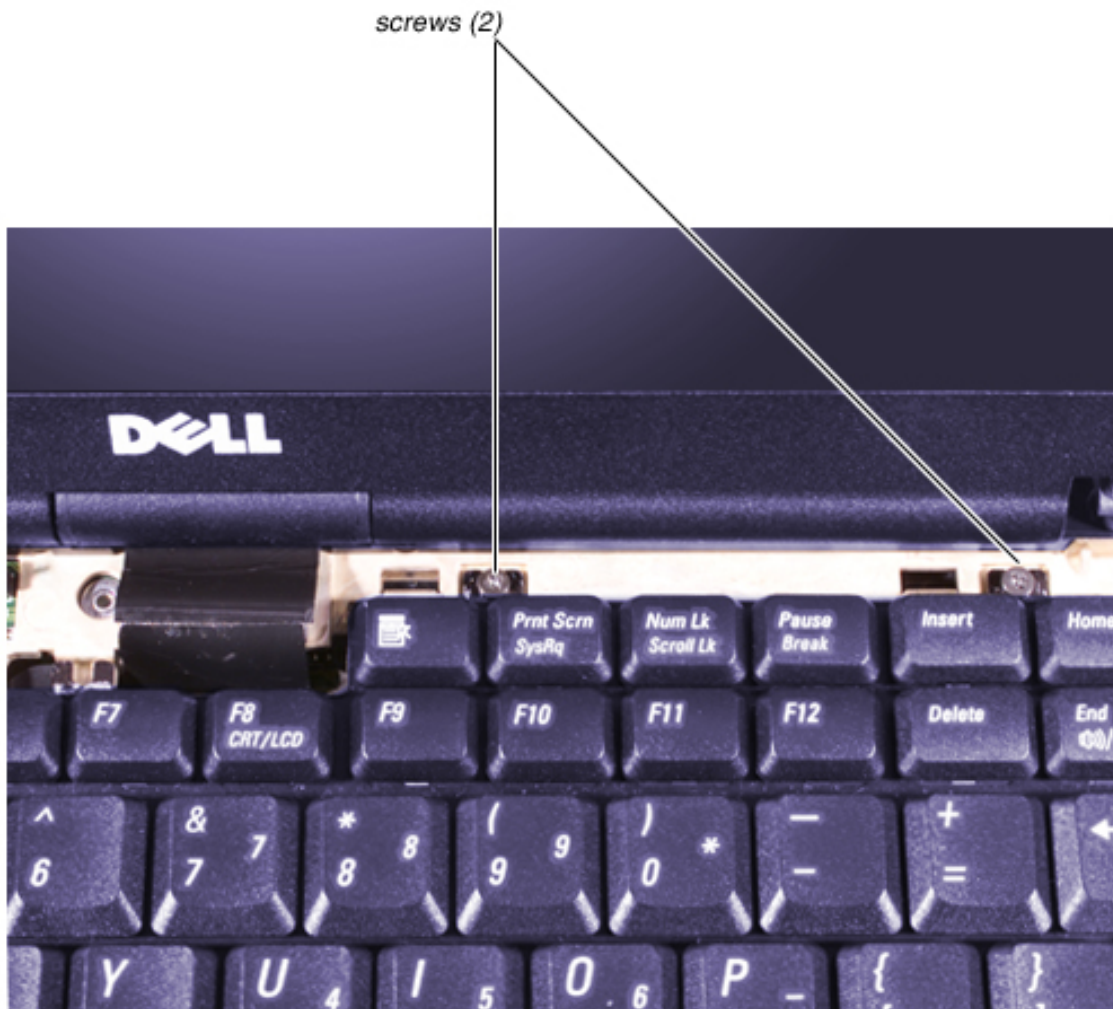

3. Detach the cable from the [ZIF connector](#).

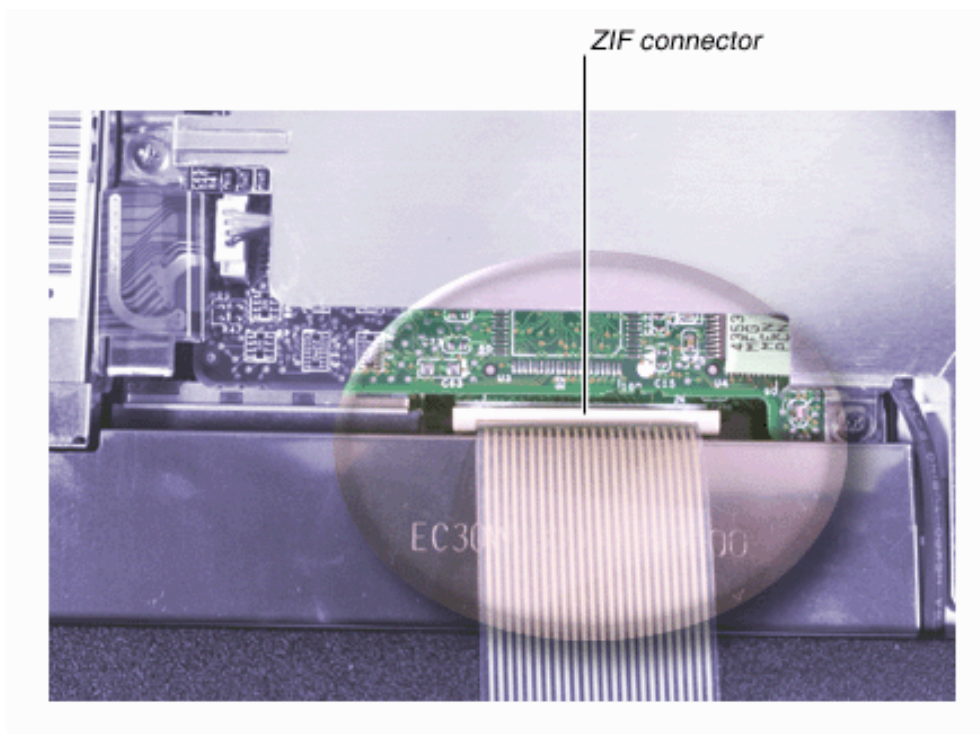

Thermal Shield Removal

NOTICE: Only a certified service technician should perform repairs on your computer. Damage or inoperability due to servicing not authorized by Dell is not covered by your warranty.

1. Remove the thermal shield screws. Inspiron 5000 computers have 4 screws (first photo), and Inspiron 5000e computers have 5 screws (second photo).

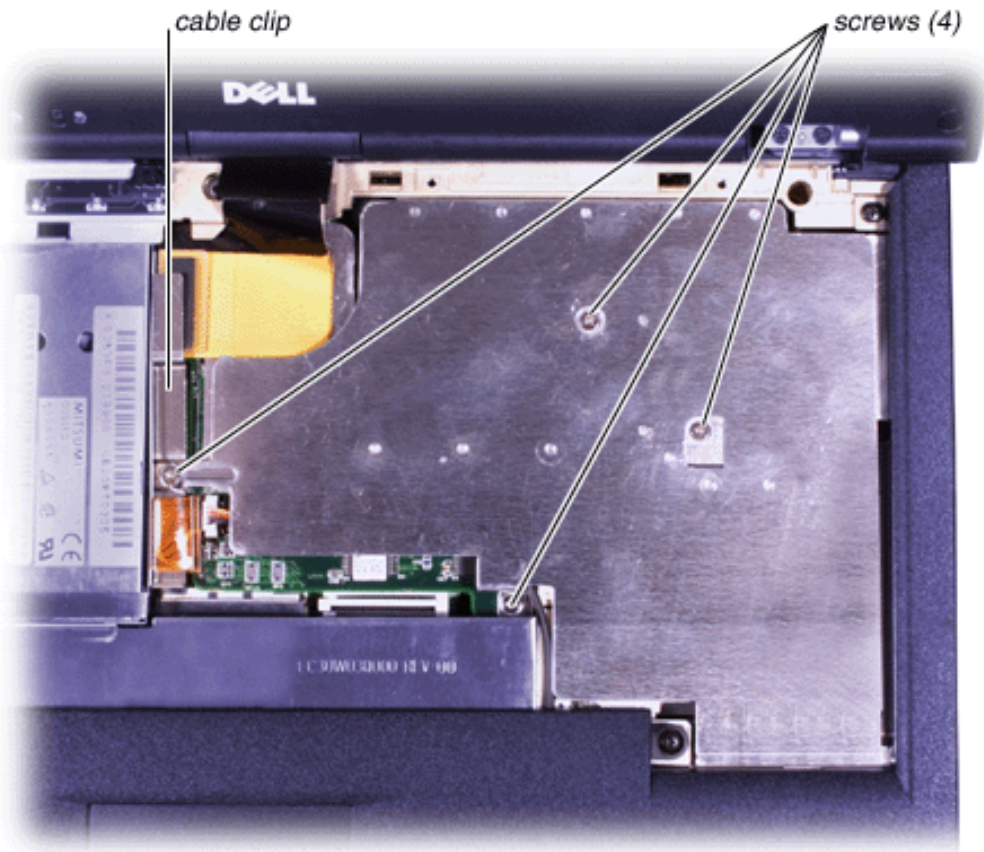

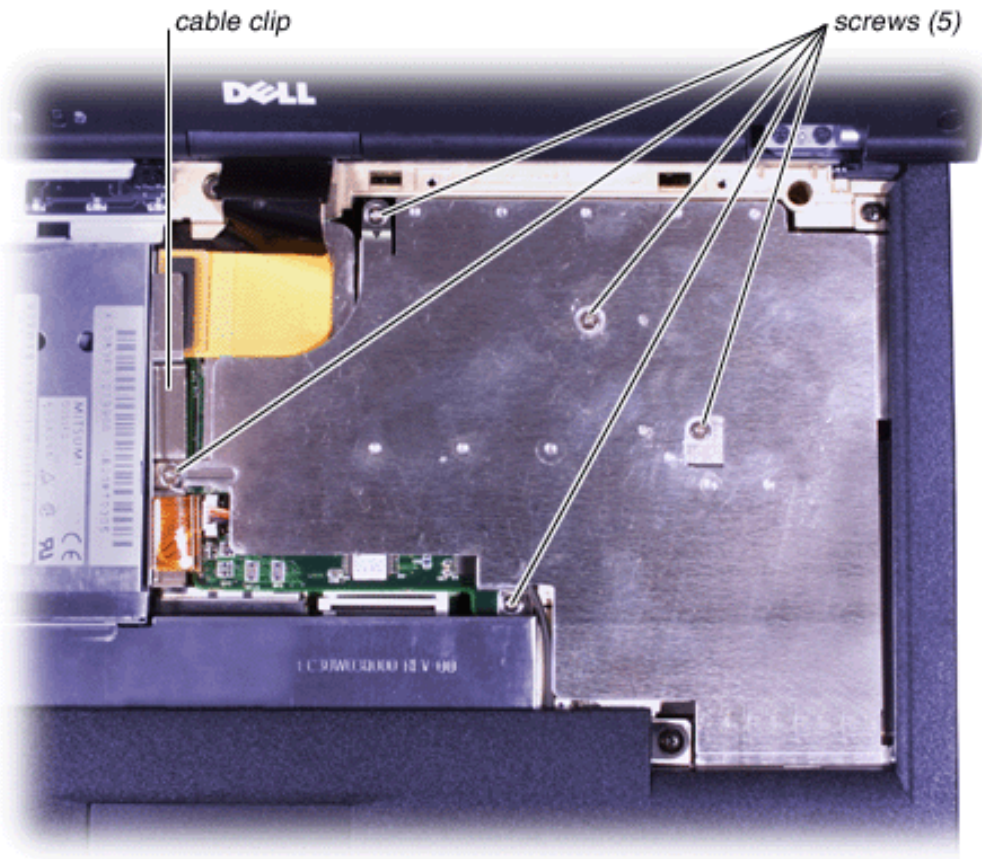

2. Remove the diskette-drive cable clip (held in place by the leftmost thermal shield screw).
3. Lift off the thermal shield.

NOTICE: Be sure to replace the diskette-drive cable clip (held in place by the leftmost thermal shield screw) when you replace the thermal shield. Failure to do so may cause the connector to become disengaged as a result of shock or vibration to the computer.

Processor Module Removal

NOTICE: Only a certified service technician should perform repairs on your computer. Damage or inoperability due to servicing not authorized by Dell is not covered by your warranty.

1. Remove the processor module screws. Inspiron 5000 computers have 3 screws (first photo), and Inspiron 5000e computers have 2 screws (second photo).

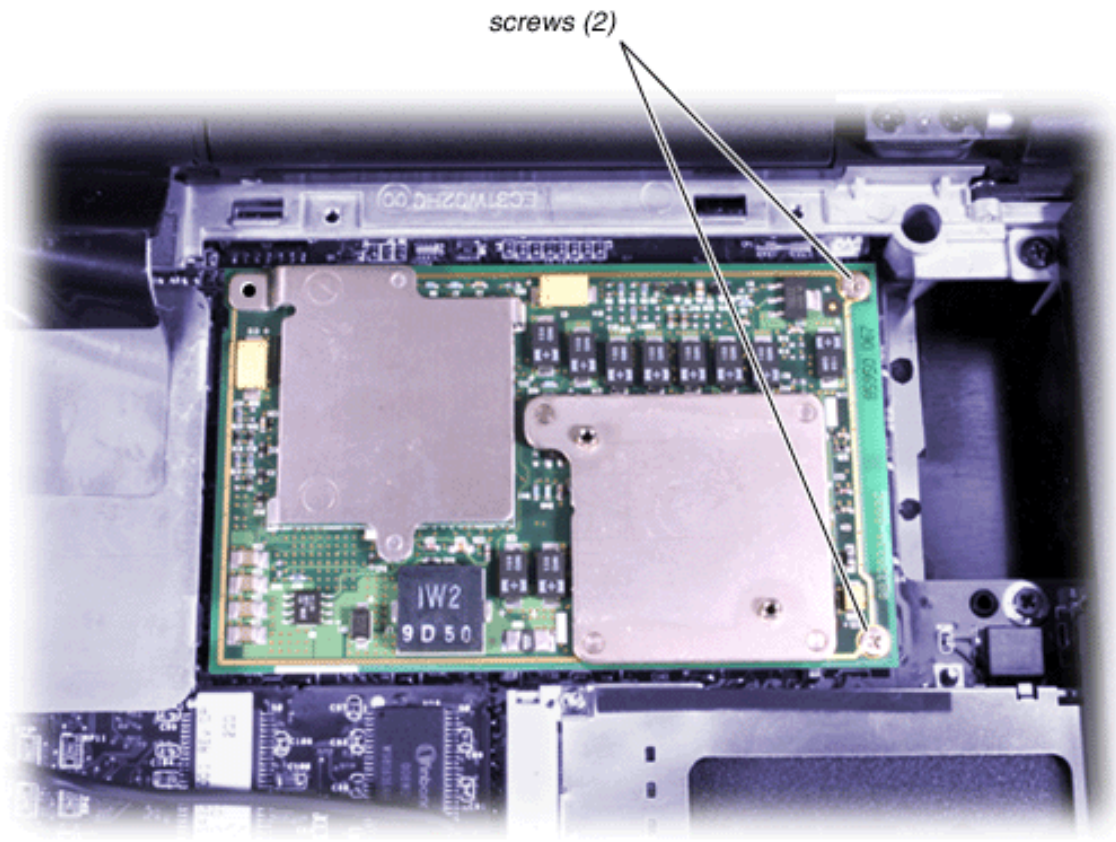
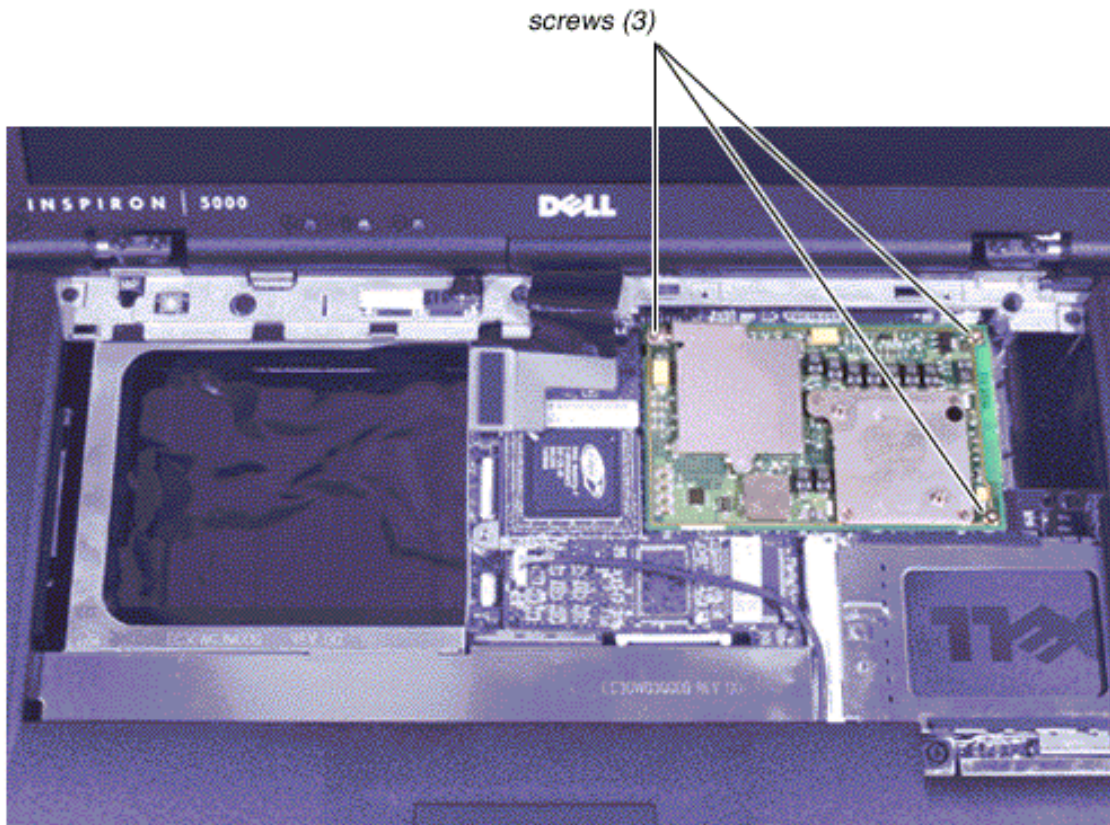

2. Lift out the module.
3. When you replace the processor, be sure to attach it to the connector.

When you replace the processor during reassembly, be sure to attach it to the connector.

LCD Removal

NOTICE: Only a certified service technician should perform repairs on your computer. Damage or inoperability due to servicing not authorized by Dell is not covered by your warranty.

1. Open the display and disconnect the LCD flex cable.
2. Close the display and remove the four LCD hinge screws.

NOTICE: Route the cable under the cable clip on computers that have extended cable clips so that the LCD flex cable will stay connected to the system board.

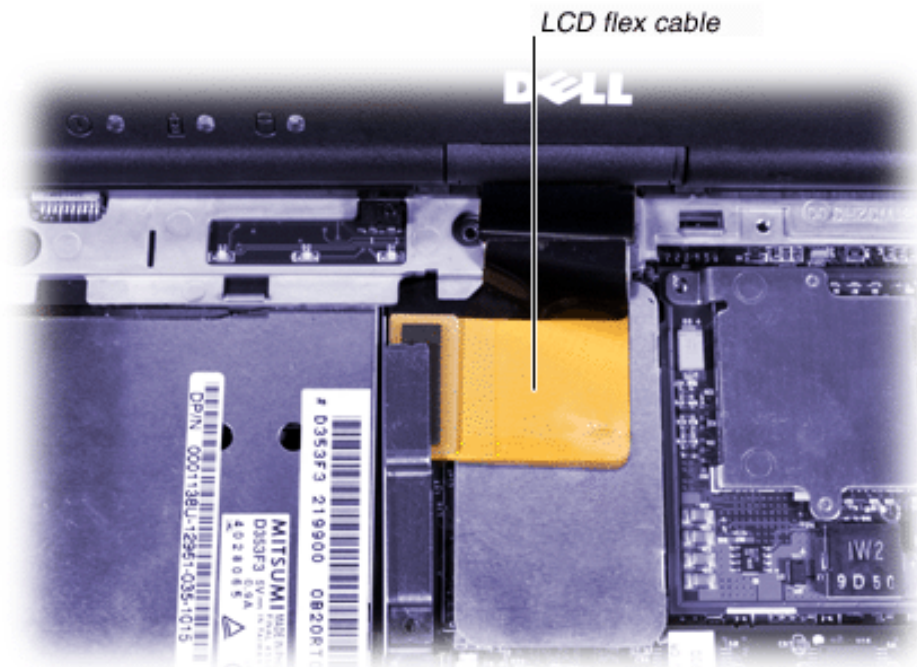

Video Board Removal

NOTICE: Only a certified service technician should perform repairs on your computer. Damage or inoperability due to servicing not authorized by Dell is not covered by your warranty.

1. Remove the screw.
2. Disconnect the touch pad cable.

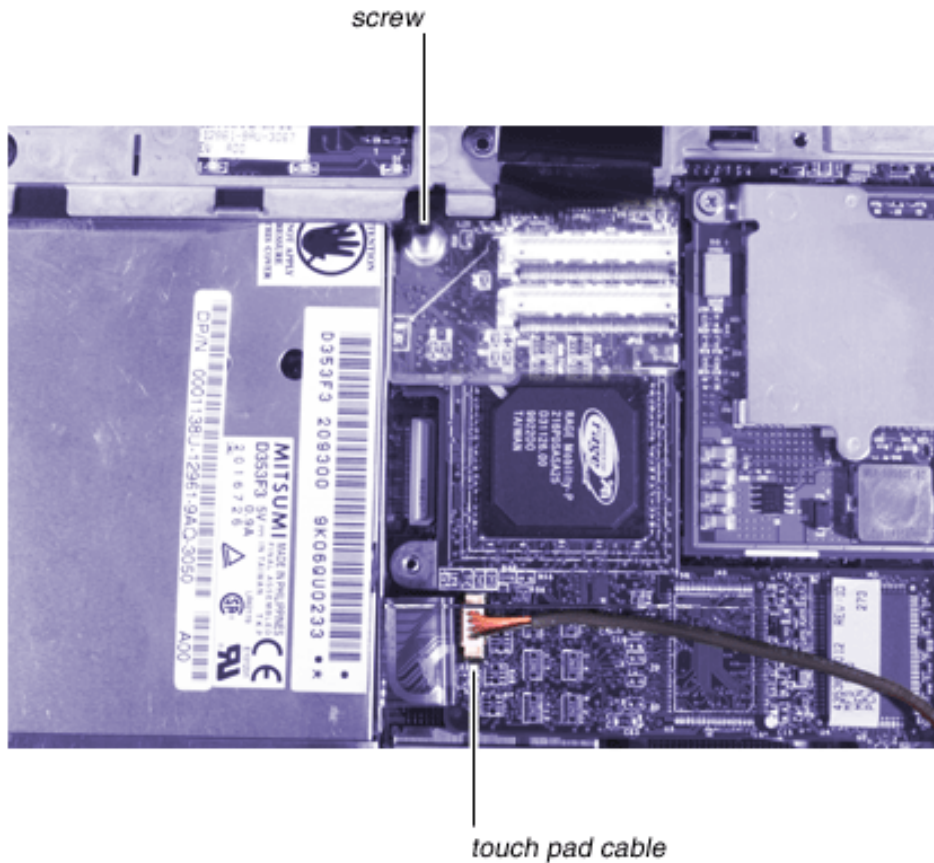

Diskette Drive Removal

NOTICE: Only a certified service technician should perform repairs on your computer. Damage or inoperability due to servicing not authorized by Dell is not covered by your warranty.

1. Detach the data cable.

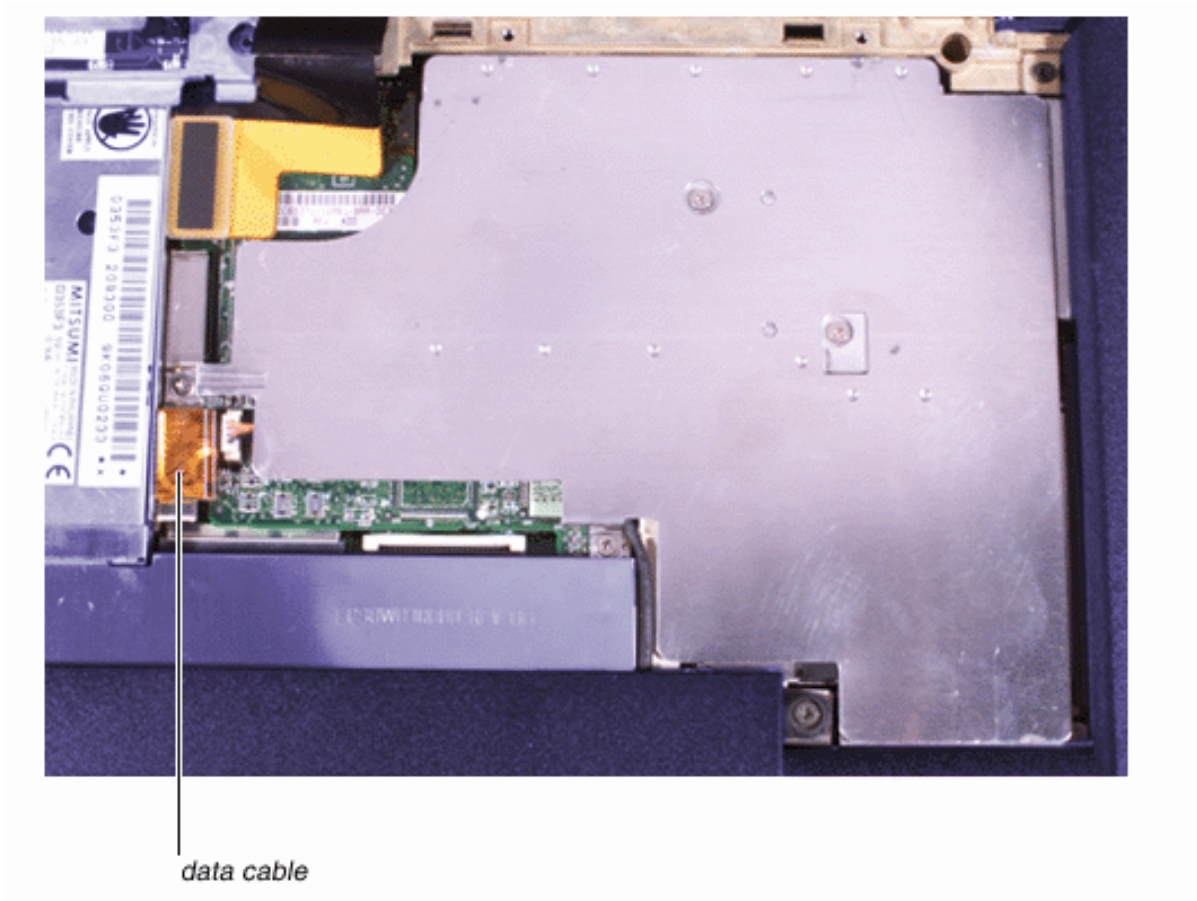

2. Remove the drive retaining screws from the bottom of the computer.

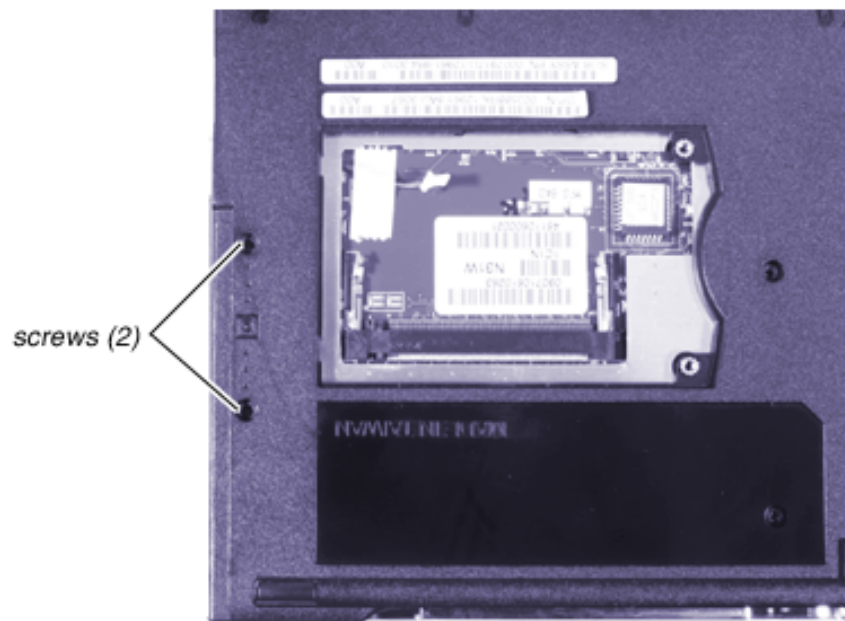

3. Remove the drive from the chassis.

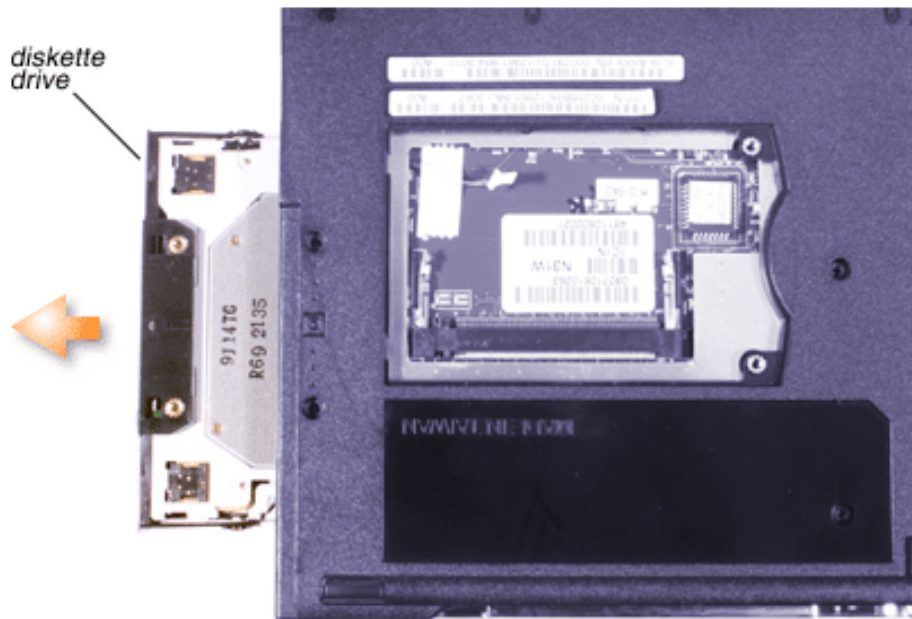

Palmrest Removal

NOTICE: Only a certified service technician should perform repairs on your computer. Damage or inoperability due to servicing not authorized by Dell is not covered by your warranty.

1. Remove the three screws from the top of the computer.

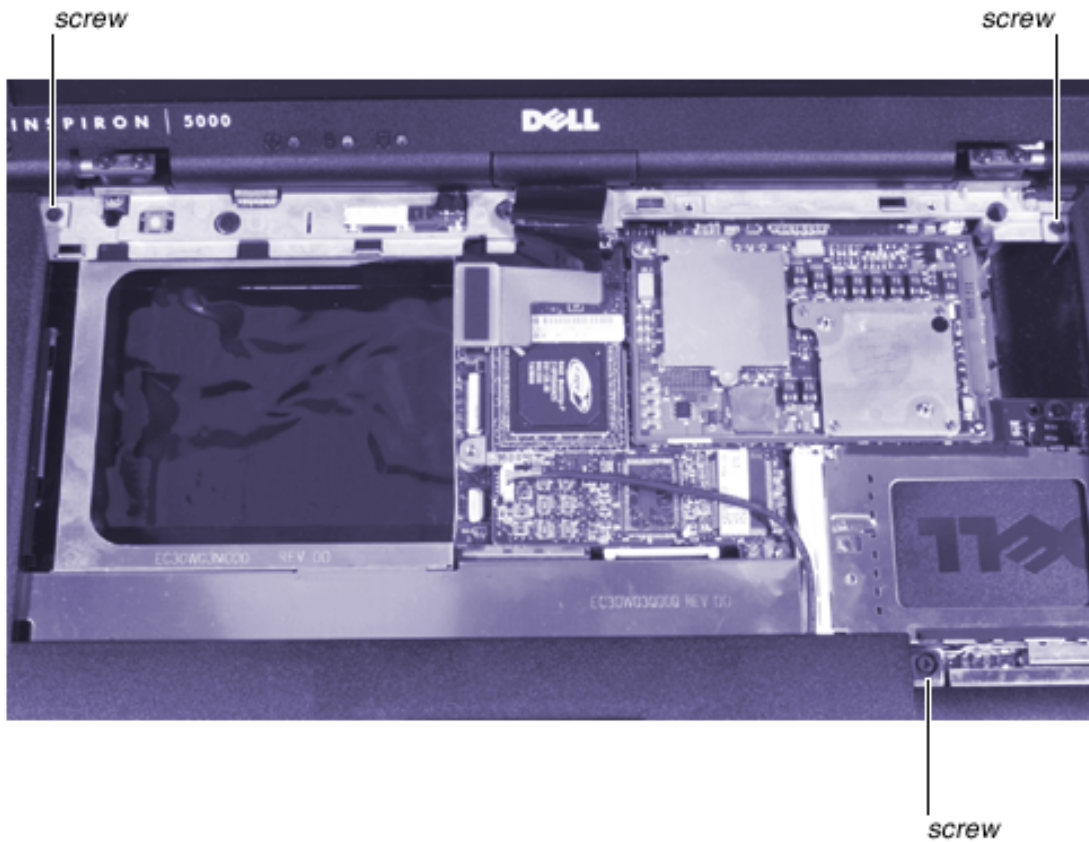

2. Remove the two screws (outer corners) from the bottom of the computer.

If you plan to remove the system board, also remove the three screws adjacent to the memory module slots and the modem.

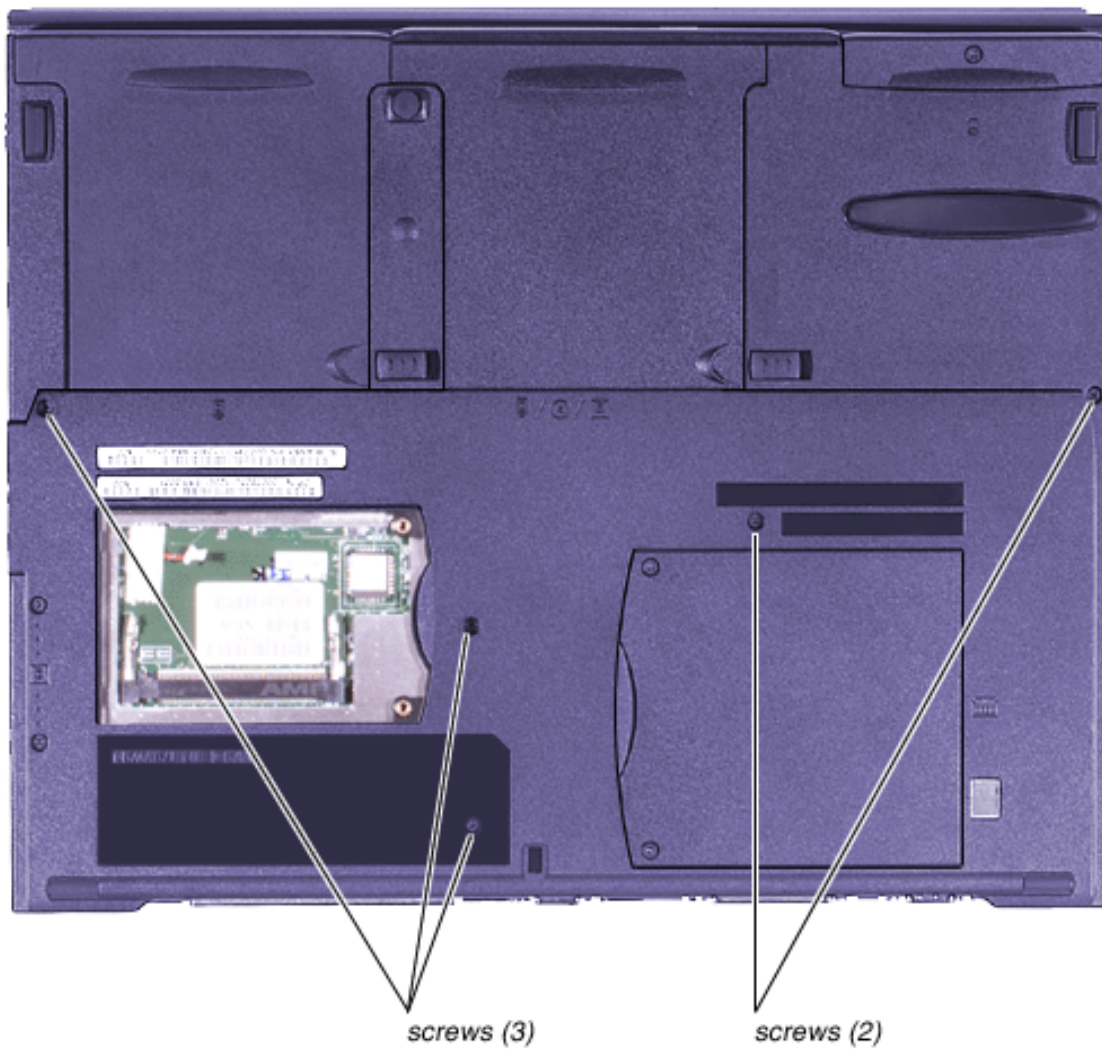

3. Remove the three screws from the hard-disk drive compartment.

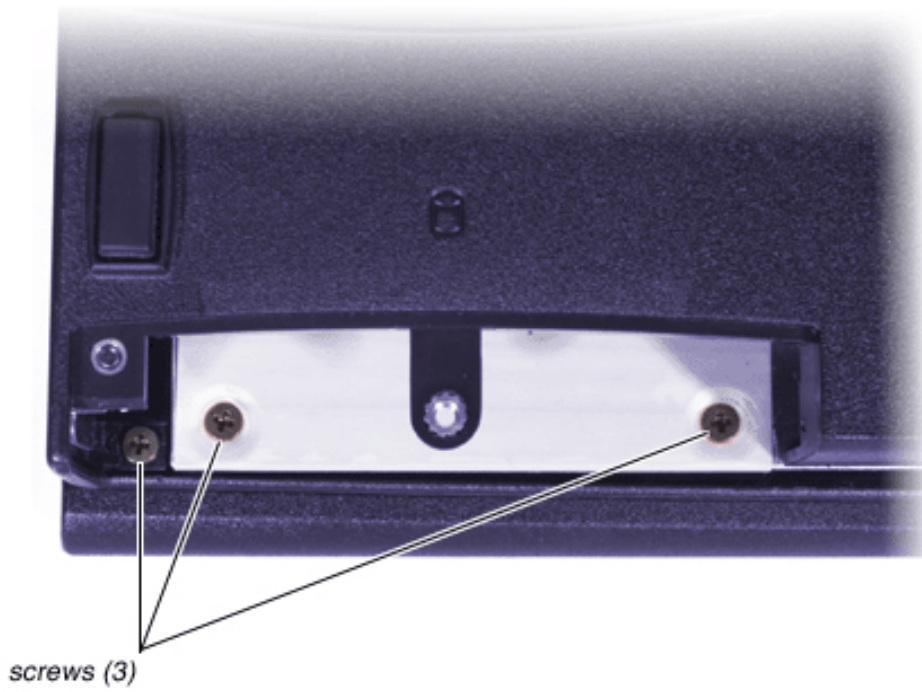

4. Remove the four screws from the battery bay.

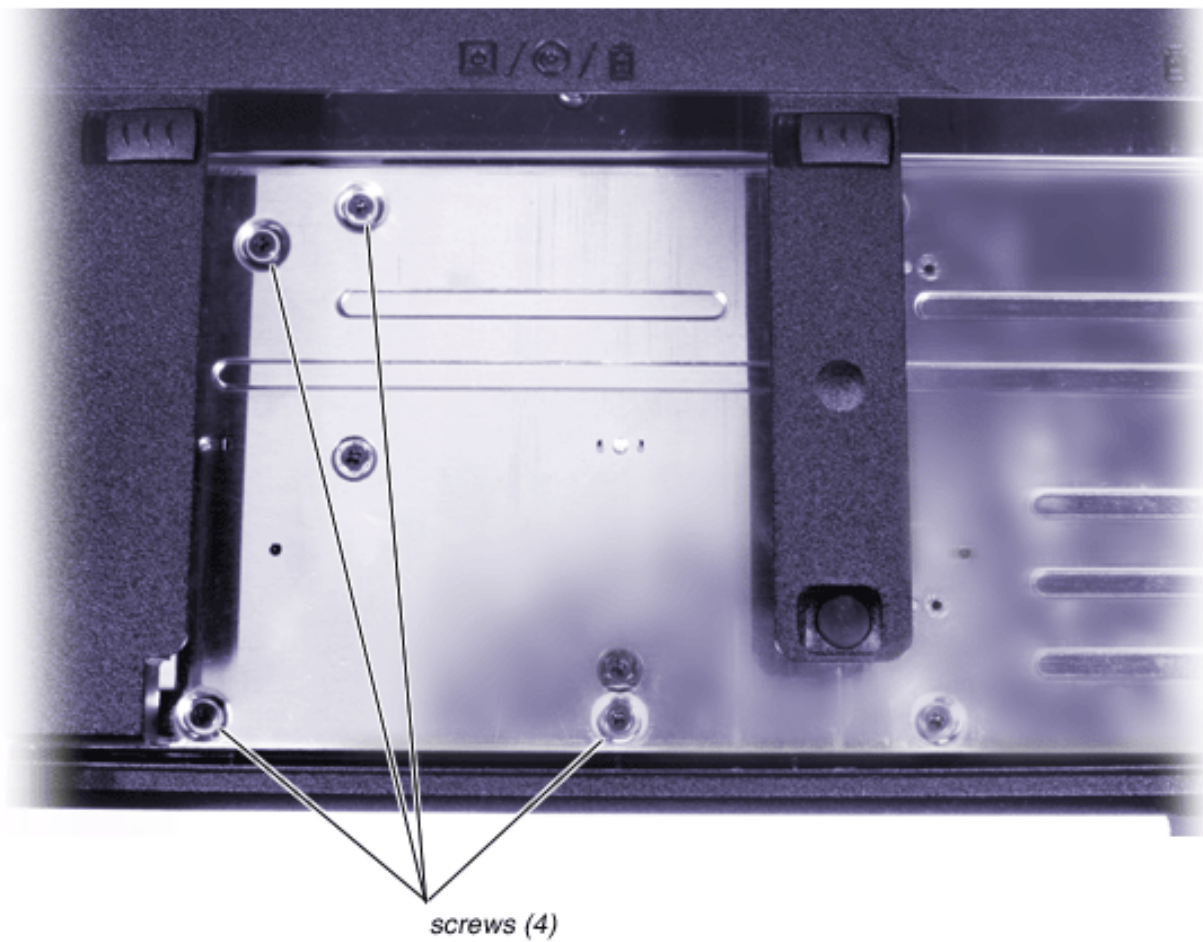

5. Remove the five screws from the media bay.

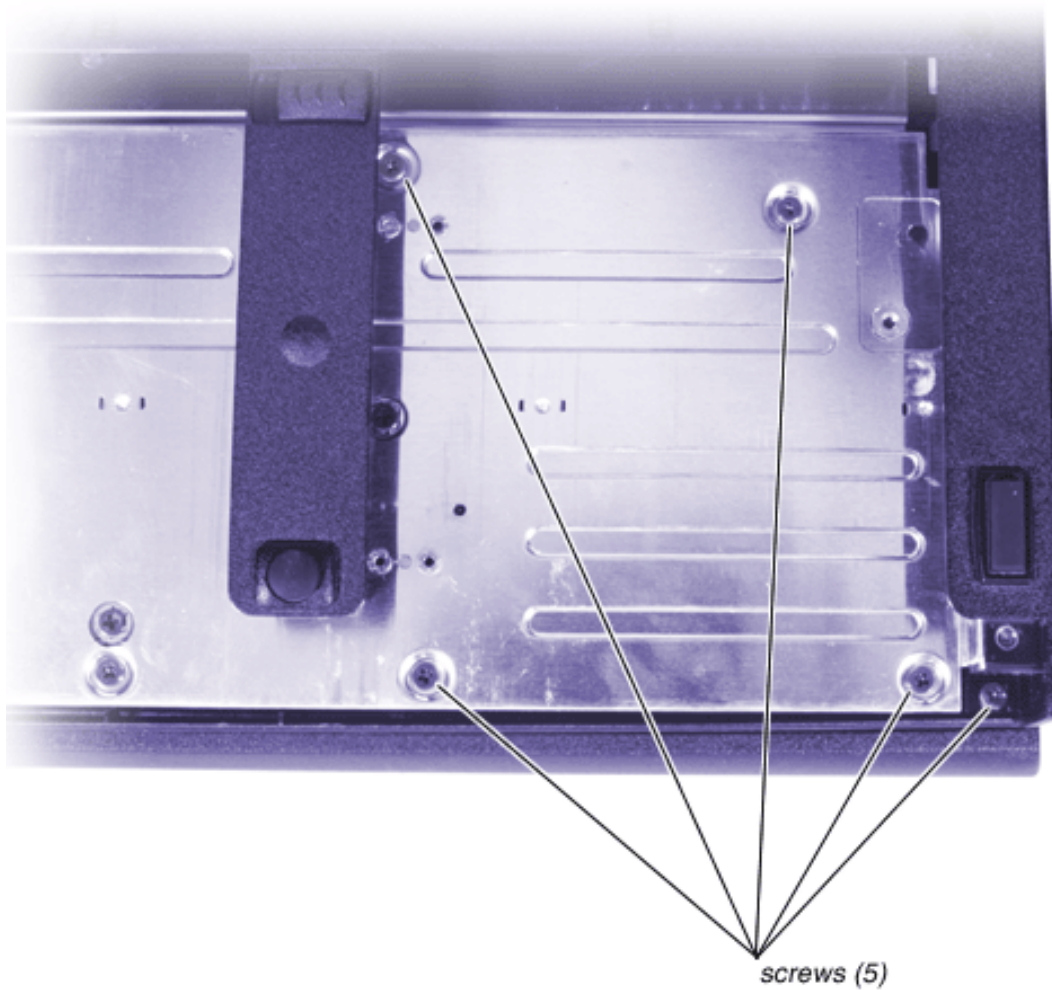

Speaker and Volume Board Removal

NOTICE: Only a certified service technician should perform repairs on your computer. Damage or inoperability due to servicing not authorized by Dell is not covered by your warranty.

1. Remove the nine screws.
2. Disconnect the speaker cable. Be sure to carefully remove the Kapton tape that holds the speaker cable in position on the left side.
3. Disconnect the volume cable.

NOTICE: When you replace the speaker and volume board, be sure not to cut the modem cable.

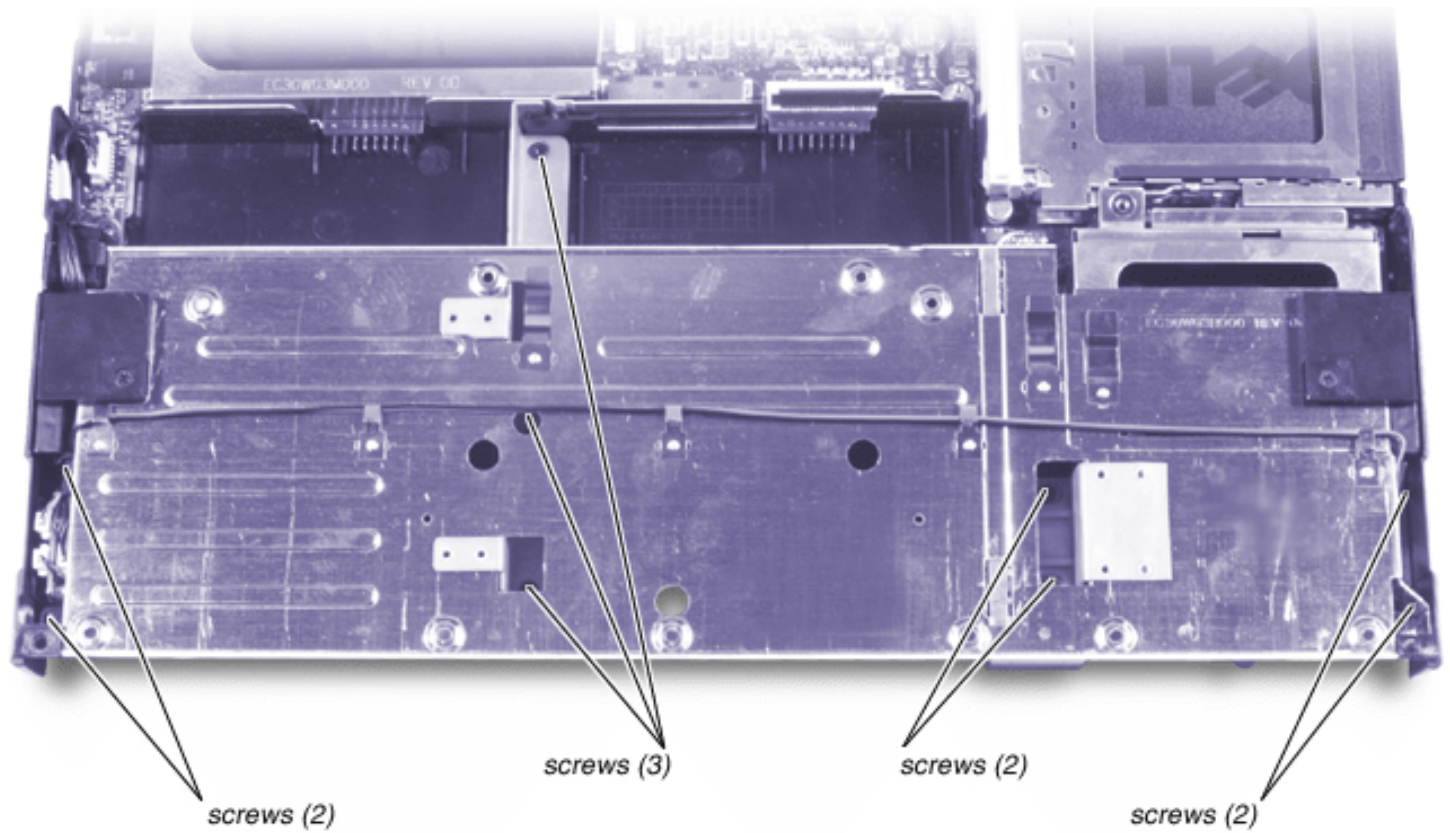

Support Rail Removal

NOTICE: Only a certified service technician should perform repairs on your computer. Damage or inoperability due to servicing not authorized by Dell is not covered by your warranty.

1. Remove the four screws.
2. Disconnect the fan cable.

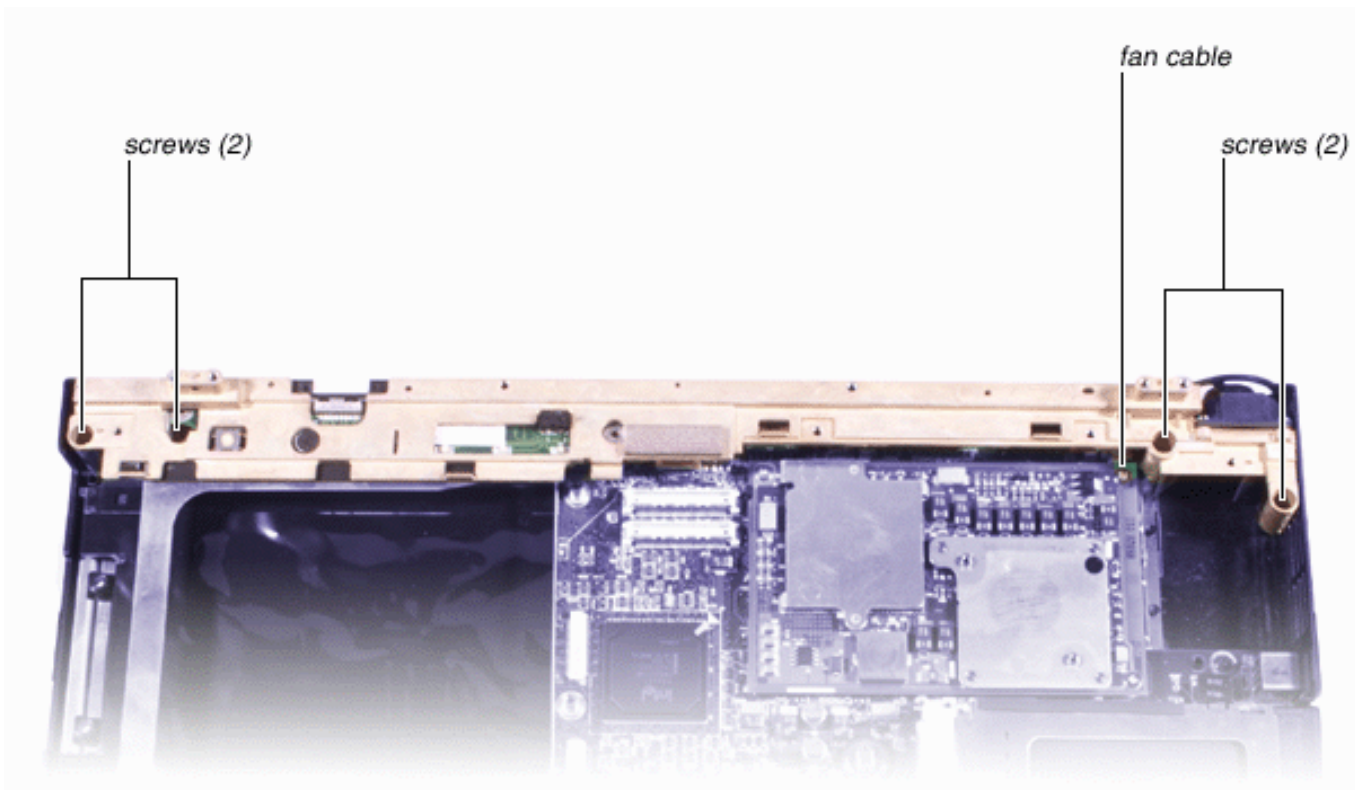

3. Remove the seven screws from the back of the computer.

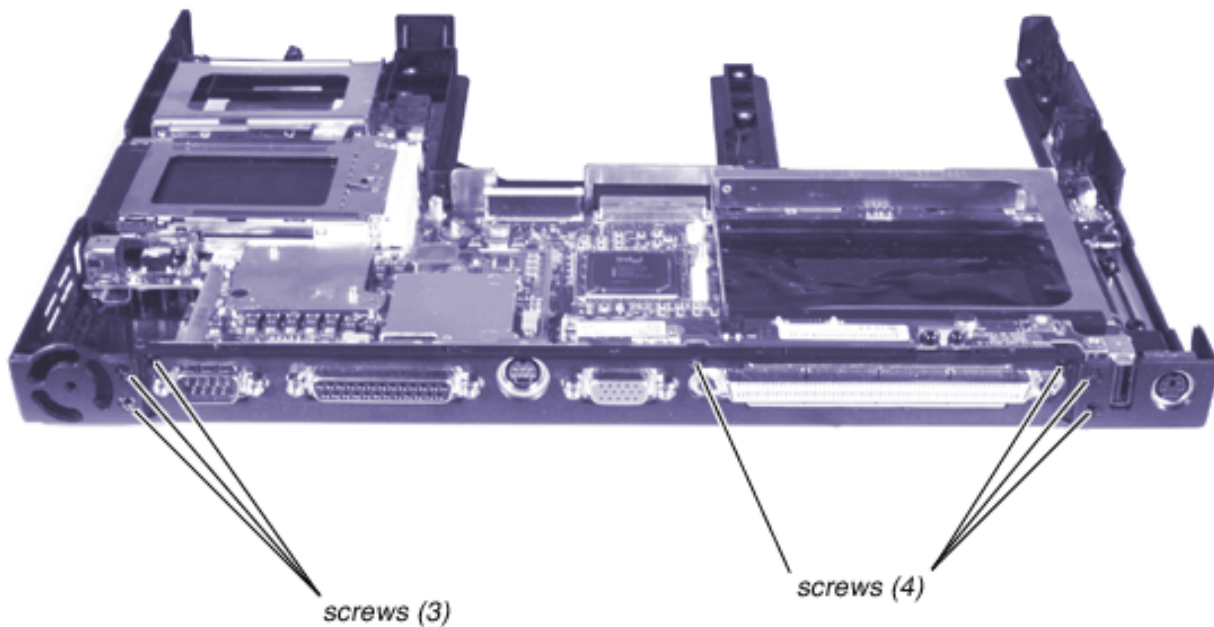

Infrared Board Removal

NOTICE: Only a certified service technician should perform repairs on your computer. Damage or inoperability due to servicing not authorized by Dell is not covered by your warranty.

Disconnect the infrared board from the system board.

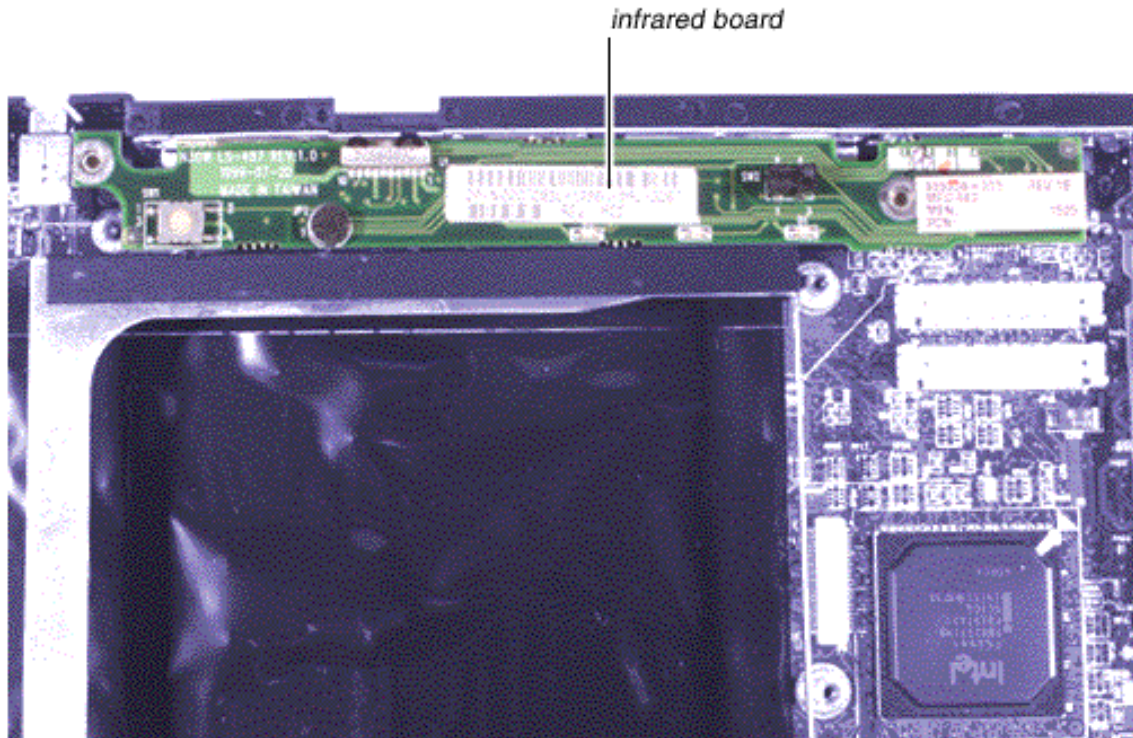

System Board Removal

NOTICE: Only a certified service technician should perform repairs on your computer. Damage or inoperability due to servicing not authorized by Dell is not covered by your warranty.

1. Remove the two screws.

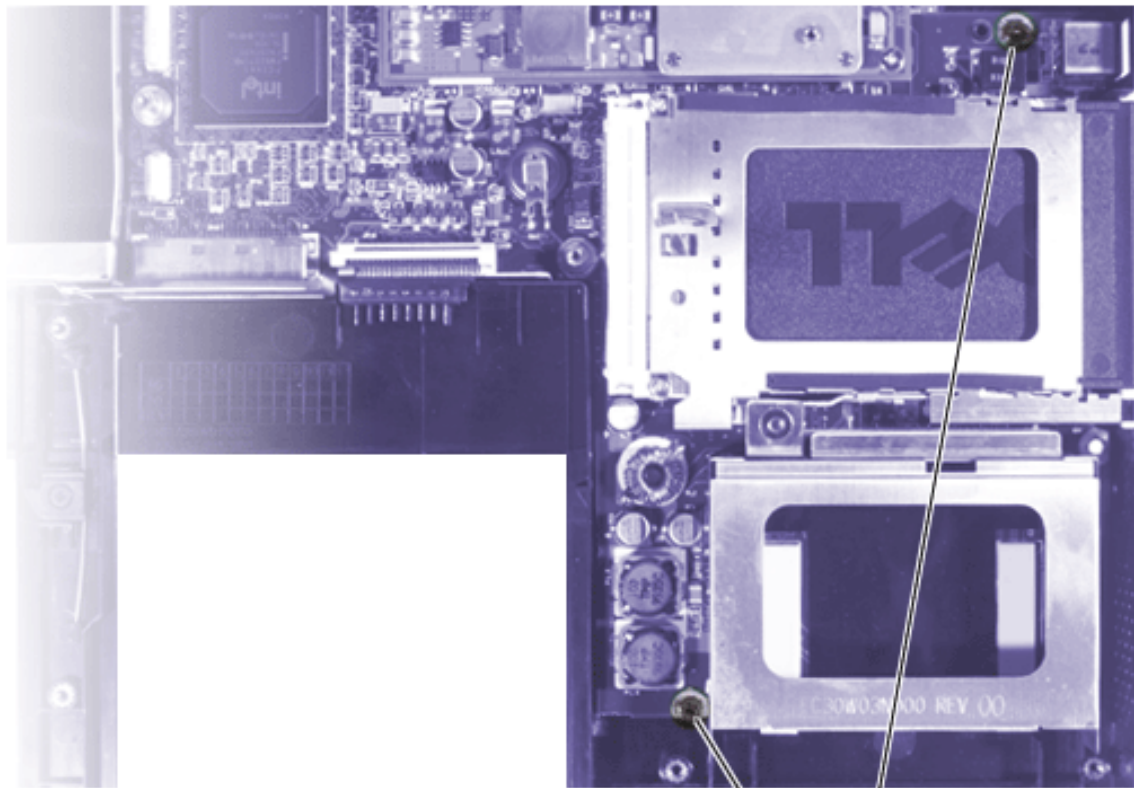

screws (2)

2. Remove the eight I/O port nuts.

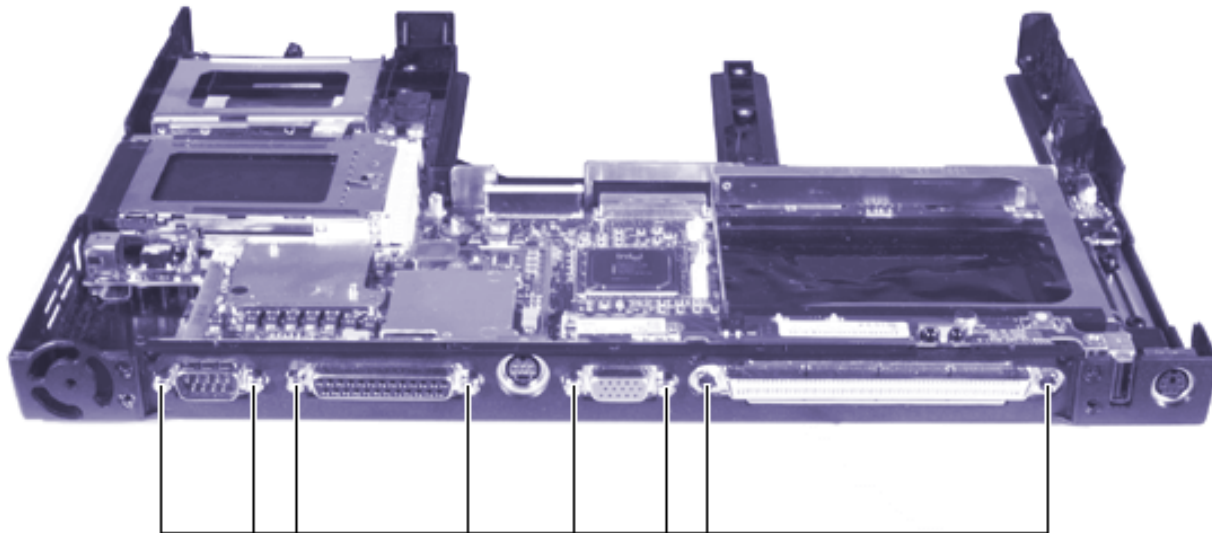

nuts (8)

3. Flex the base plastics to separate the system board from the audio connector posts on the left side of the computer.

4. Lift the system board up and out from the base plastics.

14.1-Inch XGA Display Disassembly

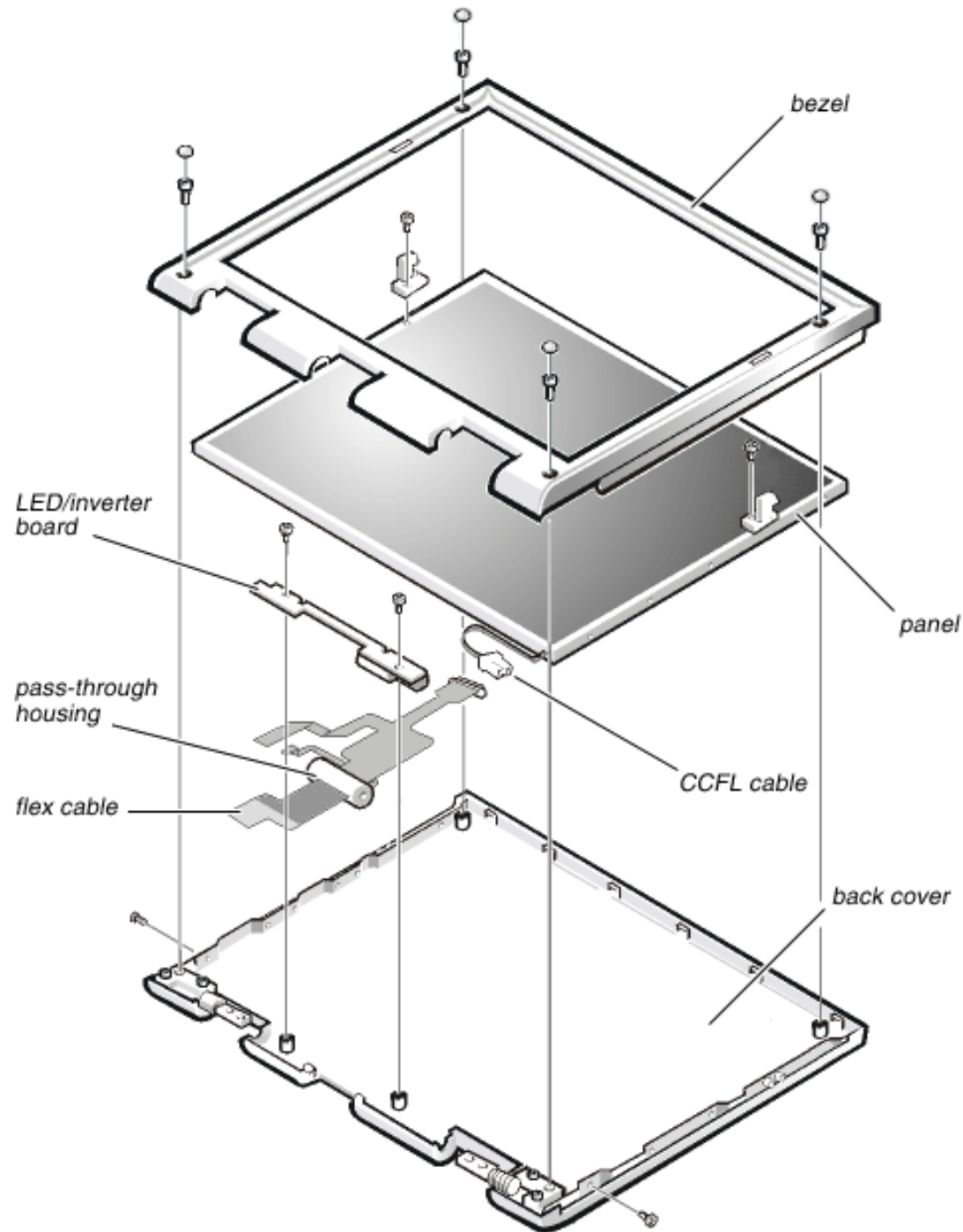

Bezel Removal

1. Remove the two screw covers from the bottom corners of the LCD bezel.
2. Remove the two bumpers from the top corners of the LCD bezel.
3. Remove the four screws from the corners of the LCD bezel.
4. Ease your fingers under the bezel on the bottom of the bezel.
Work your way around the bezel and disengage all the retaining tabs.

5. Once you have disengaged all of the retaining tabs, lift the bezel from the LCD panel.

Panel Removal

NOTICE: It is not necessary to remove the display locking tabs when removing the panel.

1. Remove the two screws from each side of the panel.
2. Disconnect the cold cathode fluorescent lamp (CCFL) cable from the bottom of the panel.
3. Disconnect the flex cable from the back of the LCD panel.
4. Lift the panel from the back cover.

LED/Inverter Board Removal

1. Remove the two screws from the LED/inverter board.
2. Disconnect the flex cable from the ZIF connector on the bottom side of the LED/inverter board.

Flex Cable Removal

1. Remove the grounding tape that secures the wire harness to the back cover.
 2. Carefully snap out the flex cable pass-through housing from the back cover.
 3. Ease the flex cable over to one side.
 4. Insert a flat instrument into the wide opening of the pass-through housing.
Be careful not to damage the flex cable.
 5. Carefully ease the cover from the pass-through housing.
-

15-Inch UXGA, XGA, and SXGA+ Display Disassembly

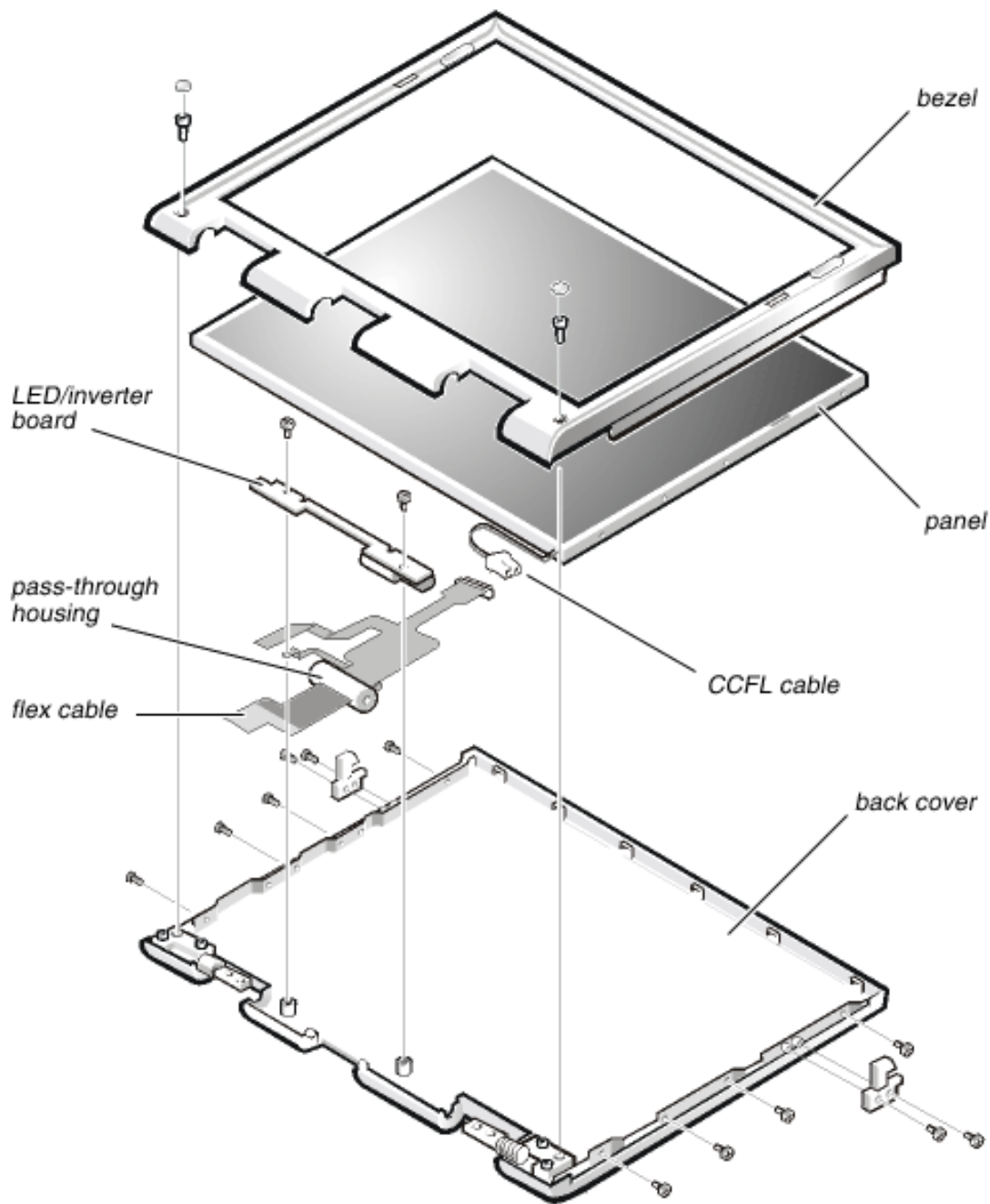

Bezel Removal

1. Remove the two screw covers from the bottom corners of the LCD bezel.
2. Remove the two screws from the bottom corners of the LCD panel.
3. Ease your fingers under the bezel at the top of the panel.
Work your way around the bezel and disengage all the retaining tabs.
4. Once you have disengaged all of the retaining tabs, lift the bezel from the LCD panel.

Panel Removal

1. Remove the two latch assembly screws from each of the two display locking tabs.
2. Remove the four screws from each side of the LCD panel.

3. Disconnect the CCFL cable from the bottom of the panel.
4. Disconnect the flex cable from the LCD panel.
5. Lift the LCD panel from the back cover.

LED/Inverter Board Removal

1. Remove the two screws from the LED/inverter board.
2. Disconnect the flex cable from the ZIF connector on the bottom side of the LED/inverter board.

Flex Cable Removal

1. Remove the grounding tape that secures the wire harness to the back cover.
2. Carefully snap out the flex cable pass-through housing from the back cover.
3. Ease the flex cable over to one side.
4. Insert a flat instrument into the wide opening of the pass-through housing.

Be careful not to damage the flex cable.

5. Carefully ease the cover from the pass-through housing.
-